

08

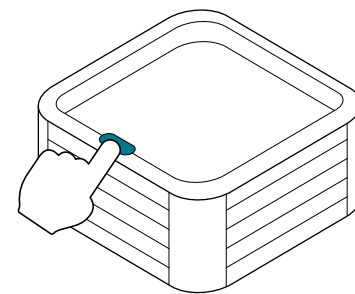

ON



Restore the power supply to the Hot tub to turn on the unit

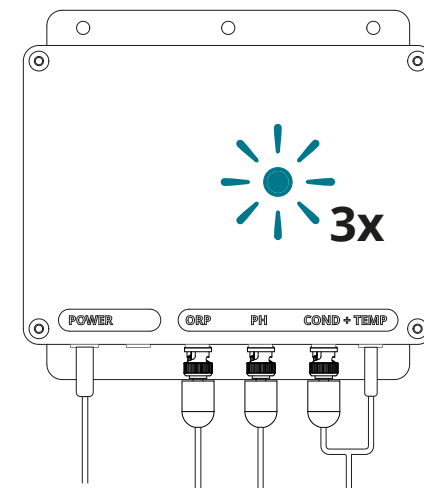

09



ICO by Ondilo



Download the application (free App)



Download the application on the user's phone

10

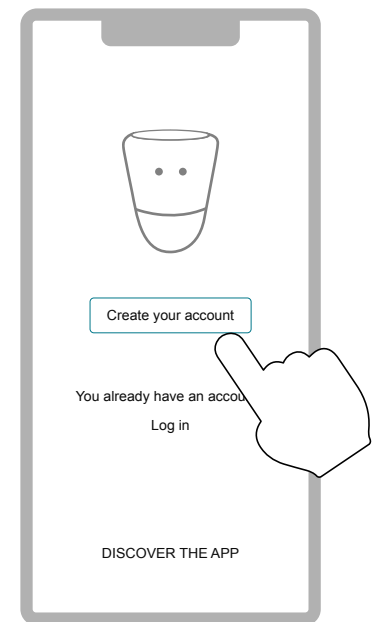

Create your account

11

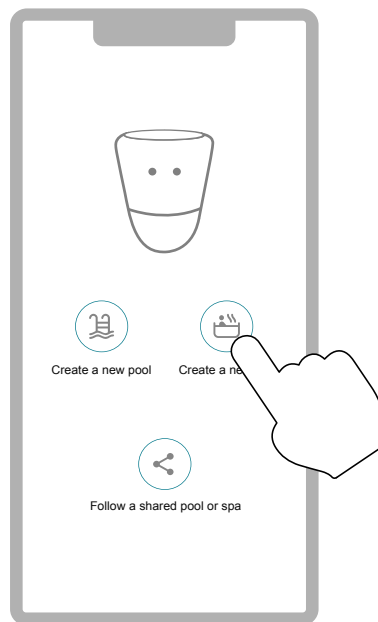

Create a new spa

12

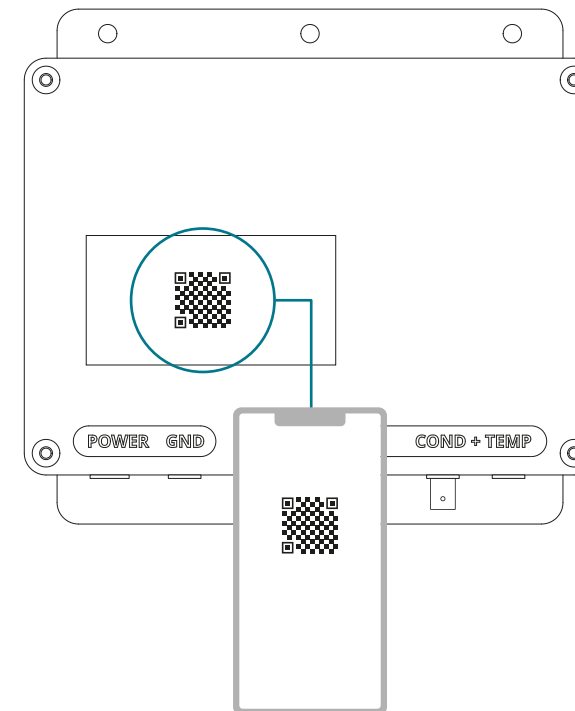

Scan QR code and follow the instructions

13

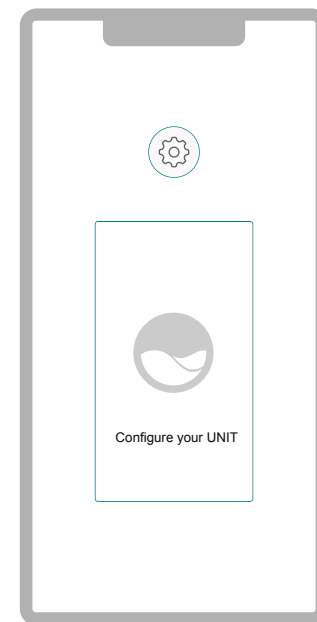

Configure your UNIT

Follow the WiFi connection steps in the app

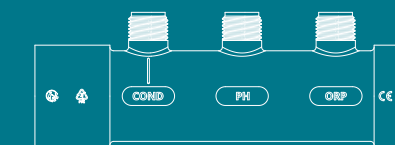
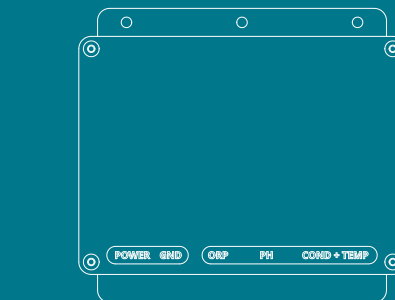

01

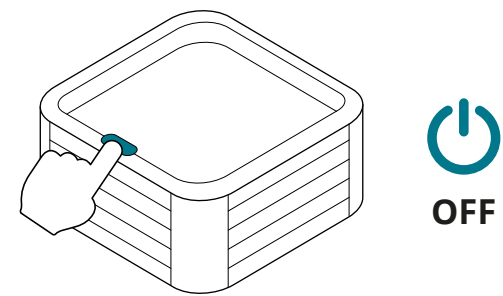

Power off the Hot tub

For your safety, it is best to turn off the main power supply

02

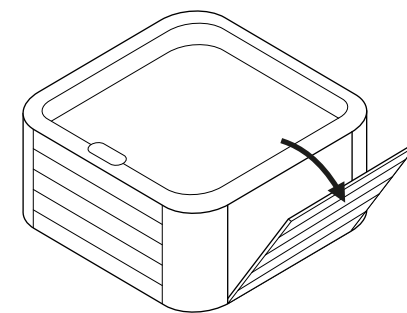

Open the side panel of your the Hot tub to access the unit control box



Installation must be done by a professional

03

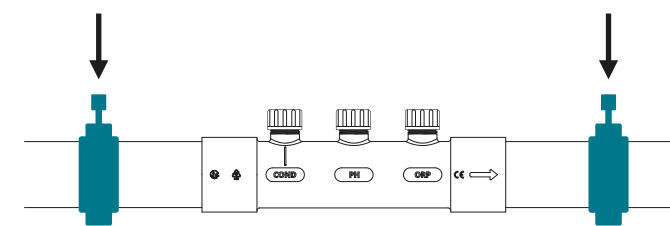

Close the slice valves

04

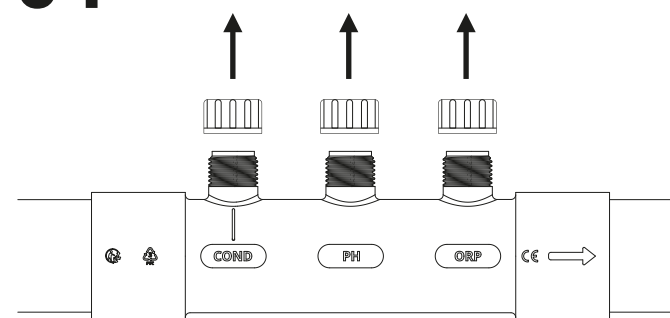

Remove the manifold caps

05

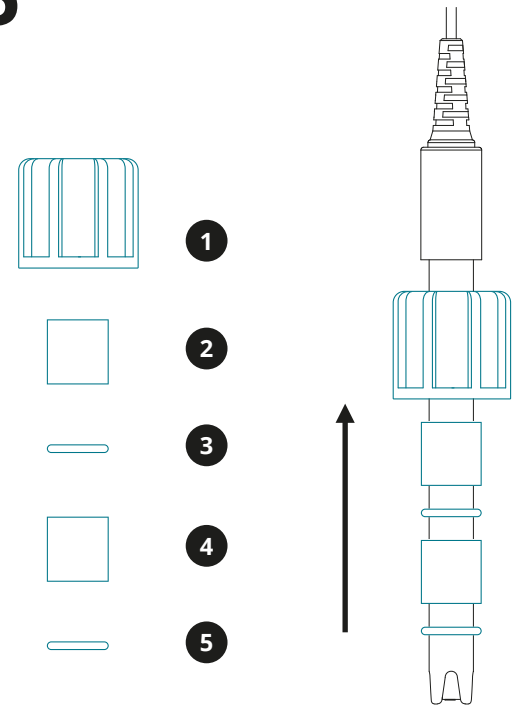

Install the compression fittings



Store the sensor boxes and end caps

06

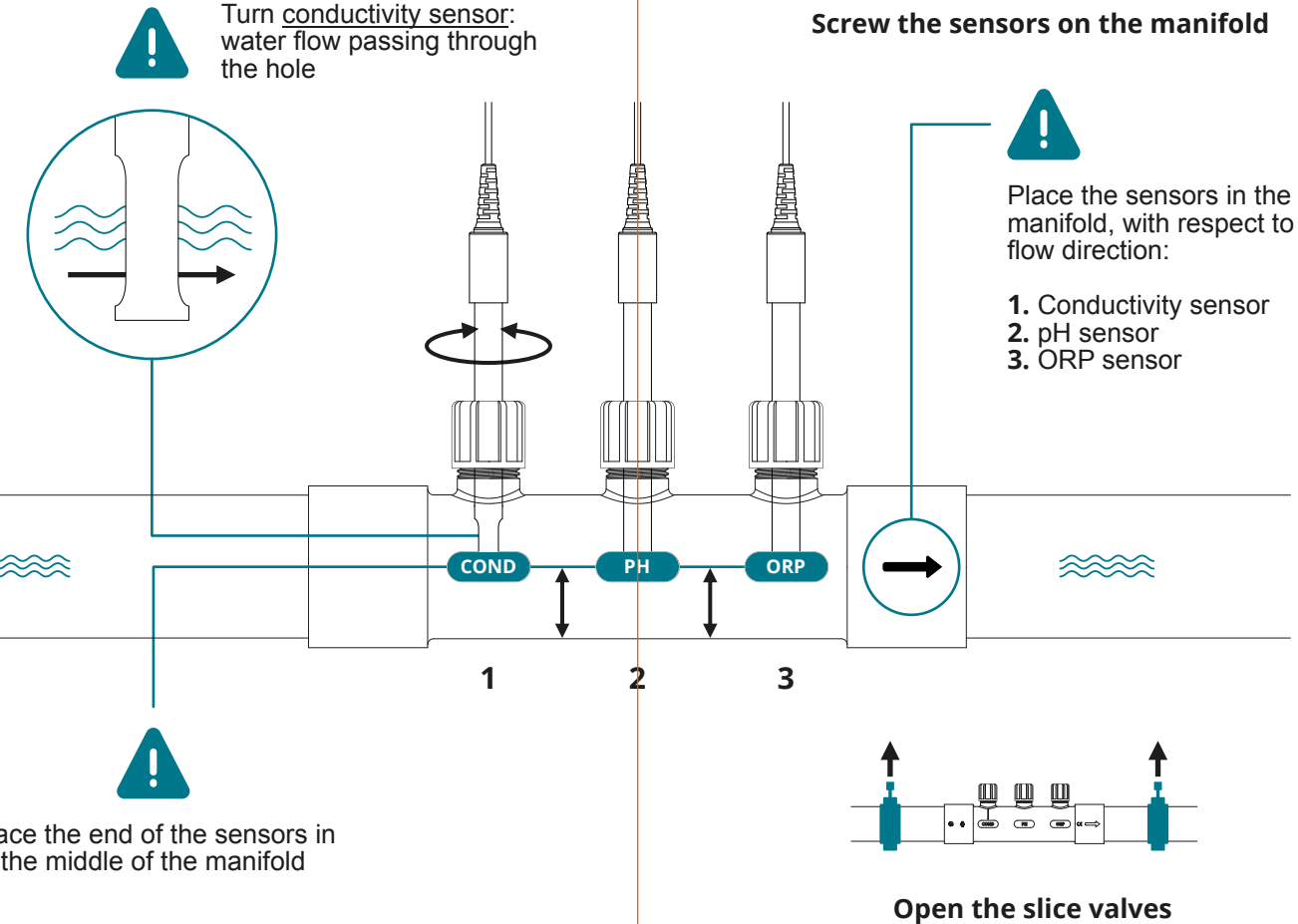

07

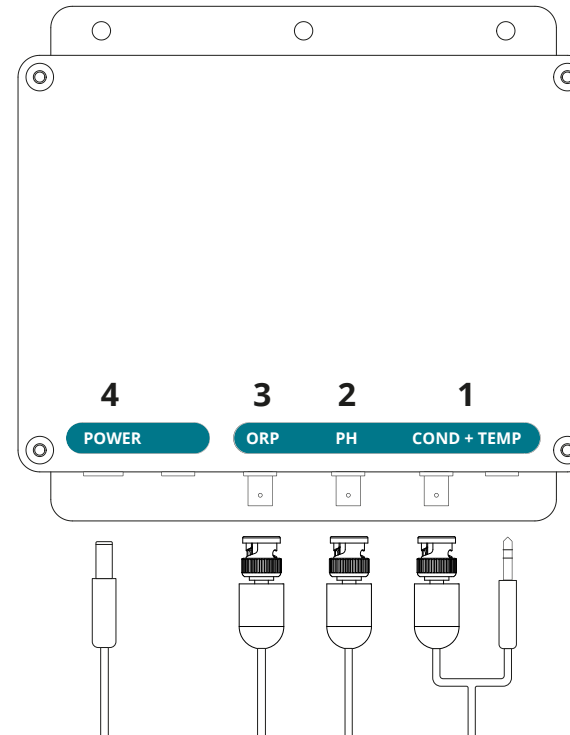

Connect the sensors to the control box



ANY QUESTIONS?